

## Q Series Remotes

Q1 / Q2 / Q4 / Q5

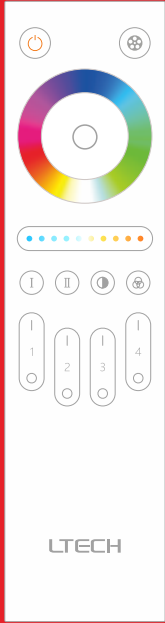

LTECH

Manual

[www.ltech-led.com](http://www.ltech-led.com)

## System Diagram

### L-BUS

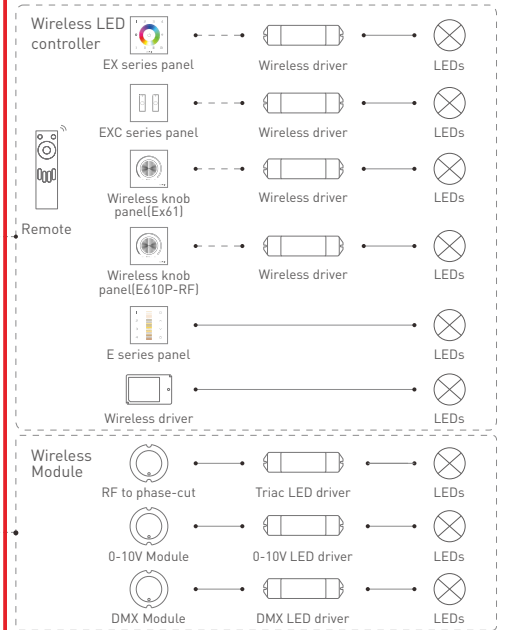
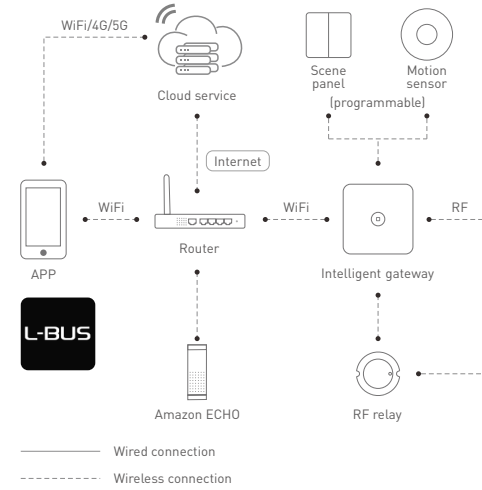

## Product Introduction

Q series remotes are 4-zone RF 2.4GHz remotes with ON/OFF, dimming and color changing functions. Color and brightness can be displayed by indicator lights. Within the effective range, Q series remotes are capable of connecting any F series wireless drivers and keeping the lighting effects in sync. Q series remotes also work with our EBOX series wireless module and touch panels.

## Technical Specs

Remote Type: 4-zone control Working Temp.: -20°C~55°C  
Power Supply: 2 pack\*AAA battery Dimensions: L162xW42xH15(mm)  
Wireless Type: RF 2.4GHz Weight(G.W.): 85g

## Dimensions Unit: mm

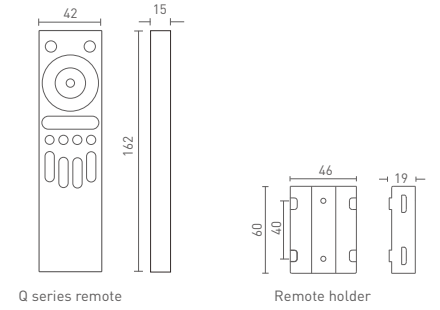

## Key Functions

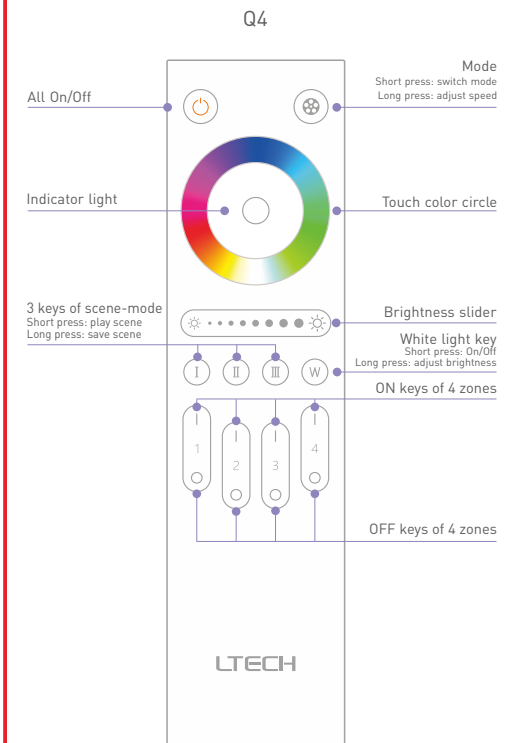
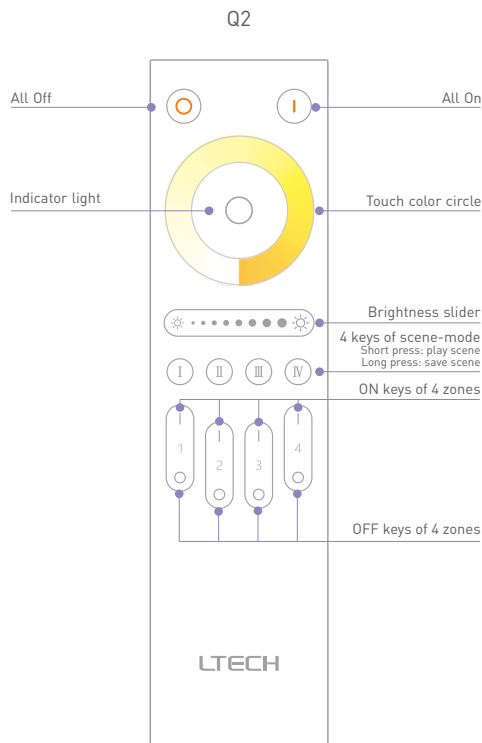
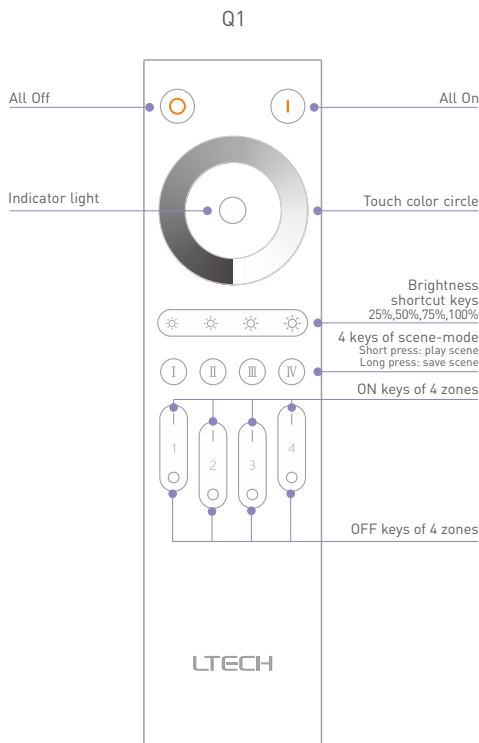

- Short press the ON key of one zone to turn on the light and select this zone; short press the OFF key of the zone to turn off the light and deselect this zone.
- If you select a zone and within 3s press the ON key of another zone, you can control 2 selected zones;
- If you select one of the previously selected zones again within 3s, only this zone will be selected [For example: If you select Zone 1 and Zone 2, and press the ON key of Zone 2 again within 3s, only Zone 2 will be selected.
- This control area on the remote is used to control the selected zones before you turn lights off.

### Mode

- |                  |                       |                                     |
|------------------|-----------------------|-------------------------------------|
| 1. Static red    | 2. Static green       | 3. Static blue                      |
| 4. Static yellow | 5. Static purple      | 6. Static cyan                      |
| 7. Static white  | 8. RGB jumping        | 9. 7 Colors jumping                 |
| 10. RGB gradient | 11. 7 colors gradient | 12. Static black(only turn off RGB) |

# Key Functions

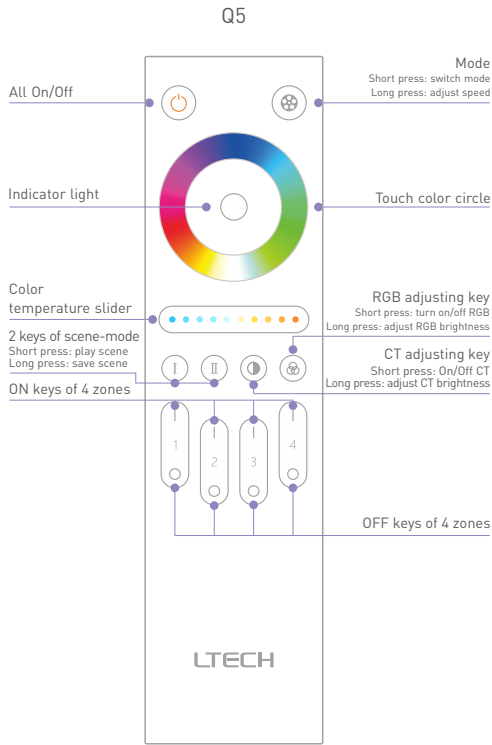

## Mode

1. Red-green jumping
2. Green-blue jumping
3. Red-blue jumping
4. RGB jumping
5. 7 Colors jumping
6. Red-green gradient
7. Green-blue gradient
8. Red-blue gradient
9. RGB gradient
10. 7 Colors gradient

# Match Code

## 1. Q series remotes work with wireless drivers

Q1/ Q2/Q4 remote works with F4-3A, F4-5A, F4-DMX-5A wireless drivers, EBOX wireless modules.  
Q5 remote works with F5-DMX-4A, EBOX-DMX-PRO wireless modules.

### Method 1

1.1.1 Power off the wireless driver.



1.1.2 Hold down "ON" key on the remote for the pairing zone, and meanwhile power on the wireless driver.

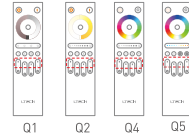

1.1.3 The lamp of wireless driver flashes several times and then stop flashing. You will hear a long beep as confirmation, then pair successfully.

### Method 2

1.2.1 Short press "ID learning button" on the wireless driver and the lamp flashes, then please complete the next step within 15s.



1.2.2 Long press the "ON" key on the remote for the pairing zone.

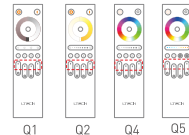

1.2.3 The lamp of wireless driver stops flashing, then pair successfully.

## 2. Q series remotes work with panels

Q1 remote works with E1/E1S/EX1/EX1S/EX5 panel;

Q2 remote works with E2/EX2/EX6 panel;

Q4 remote works with E3/E3S/E4/E4S/EX3/EX3S/EX4/EX4S/EX7/EX7S/EX8/EX8S panel;

Q5 remote works with E5S panel.

2.1 Long press "ON" on the touch panel until the indicator light flashes.



2.2 Long press the "ON" key on the remote for the pairing zone until the indicator light of the touch panel stops flashing, then pair successfully.

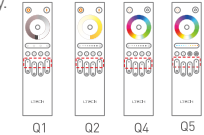

\* Please match/clear code when the touch panel is power-on (the indicator light is white).

## 3. Match code between remotes (Assuming that B pairs with A)

3.1 Short press the top two keys of remote B simultaneously, release them and the indicator light keeps on.

3.2 Press any key on remote A within 5s. When the indicator light of remote B puts out, pair successfully.

\* Only the same model remotes can pair with each other.



## Clear code

Press the top two keys on remote simultaneously for about 6s. The indicator light flashes twice, then clear code successfully.



# Wiring Diagram

## Remote works with wireless drivers

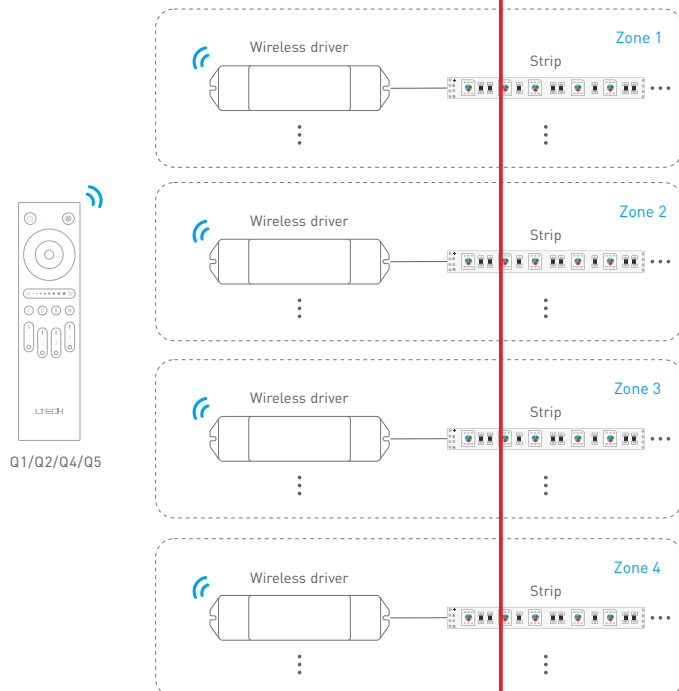

## Remote works with touch panels

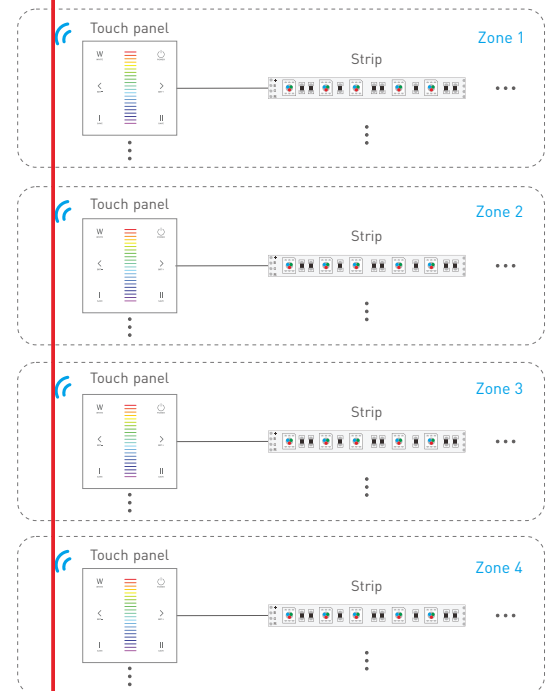

\* This manual is subject to changes without further notice. Product functions depend on the goods. Please feel free to contact our official distributors if you have any question.